

Digital Villa VTO (VTO2 series) User's Manual

V1.0.0

Table of Contents

1	Product Overview	1
1.1	Intro to Product	1
1.2	Applicable Models	1
2	Structure	2
2.1	Front Panel	2
2.2	Rear Panel	3
3	Networking Scene.....	4
4	Installation and Debug	5
4.1	Device Wiring.....	5
4.2	Device Installation	5
4.2.1	Screw.....	6
4.2.2	Installation Step	6
4.3	Debug Device	7
4.3.1	Before Debugging	7
4.3.2	Debug Device	8
4.3.3	Successfully Debug.....	11
5	Web Config.....	1
5.1	WEB Login and Logout	1
5.1.1	Login.....	1
5.1.2	Logout.....	1
5.2	System Config.....	2
5.2.1	Local Config.....	2
5.2.2	LAN Config	7
5.2.3	Indoor Manager.....	8
5.2.4	Network Config	10
5.2.5	Video Set	12
5.2.6	User Manager	14

5.2.7	IPC.....	16
5.2.8	WIFI Info	17
5.3	Info Search.....	17
5.3.1	Call History	18
5.3.2	Alarm Record	18
5.3.3	Unlock Record	18
5.4	Status Statistics	19
6	Basic Function Introduction.....	20
6.1	Monitor.....	20
6.2	Call Function	20
6.3	Unlock.....	20
6.4	Restore Backup	20
	Appendix 1 Technical Specifications	21

Important Safeguards and Warnings

Please read the following safeguards and warnings carefully before using the product in order to avoid damages and losses.

Note:

- Do not expose the device to lampblack, steam or dust. Otherwise it may cause fire or electric shock.
- Do not install the device at position exposed to sunlight or in high temperature. Temperature rise in device may cause fire.
- Do not expose the device to humid environment. Otherwise it may cause fire.
- The device must be installed on solid and flat surface in order to guarantee safety under load and earthquake. Otherwise, it may cause device to fall off or turnover.
- Do not place the device on carpet or quilt.
- Do not block air vent of the device or ventilation around the device. Otherwise, temperature in device will rise and may cause fire.
- Do not place any object on the device.
- Do not disassemble the device without professional instruction.

Warning:

- Please use battery properly to avoid fire, explosion and other dangers.
- Please replace used battery with battery of the same type.
- Do not use power line other than the one specified. Please use it properly. Otherwise, it may cause fire or electric shock.

Special Announcement

- This manual is for reference only.
- All the designs and software here are subject to change without prior written notice.
- All trademarks and registered trademarks are the properties of their respective owners.
- If there is any uncertainty or controversy, please refer to the final explanation of us.
- Please visit our website for more information.

1 Product Overview

1.1 Intro to Product

Digital villa VTO has easy operation, simple installation and support:

- WIFI
- Mobile phone live preview
- Call VTH, and perform video talk
- Door unlock by card
- One-click MGT center
- Vandal-proof alarm and etc.

1.2 Applicable Models

Model	Color	Unlock via IC card	Button Type	Lock Control Module	POE	WIFI
VTO2111D-WP	Black	Support	Mechanical keypad	Support built-in and external	Support	Support
VTO2111D-W	Black	Support	Mechanical keypad	Support built-in and external	Not support	Support
VTO2111D	Black	Support	Mechanical keypad	Support built-in and external	Not support	Not support

2 Structure

2.1 Front Panel

Device front panel is in Figure 2-1. Description of each component is in Chart 2-1.

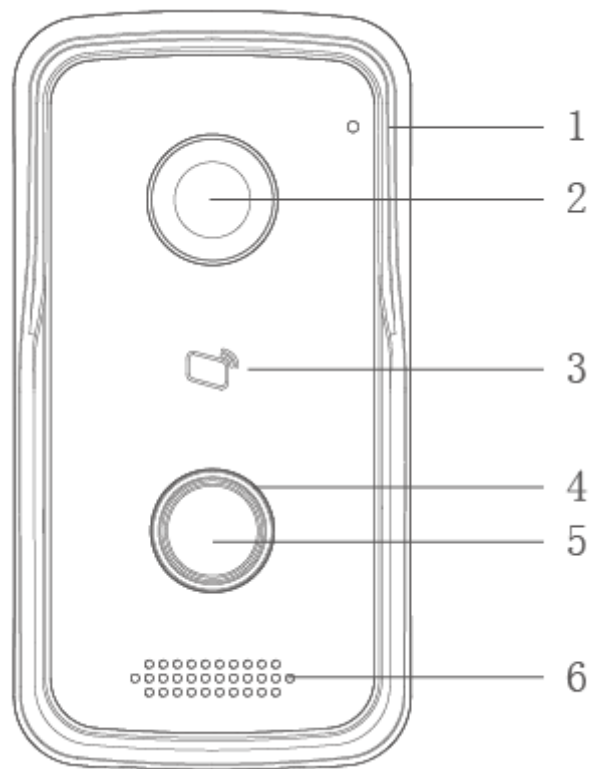

Figure 2-1

No.	Port Name	Note
1	MIC	Audio input.
2	Camera	It monitors corresponding door region.
3	Card Area	Authorize IC card to unlock (card issuing) , swipe card to unlock.
4	Indicator	<ul style="list-style-type: none"> In standby status, blue light is NO. Network offline, blue light flashes when call VTH or MGT center.
5	Call Button	Call MGT center or VTH.
6	Speaker	Audio output.

Chart 2-1

2.2 Rear Panel

Device rear panel is in Figure 2-2. Description of each component is in Chart 2-2.

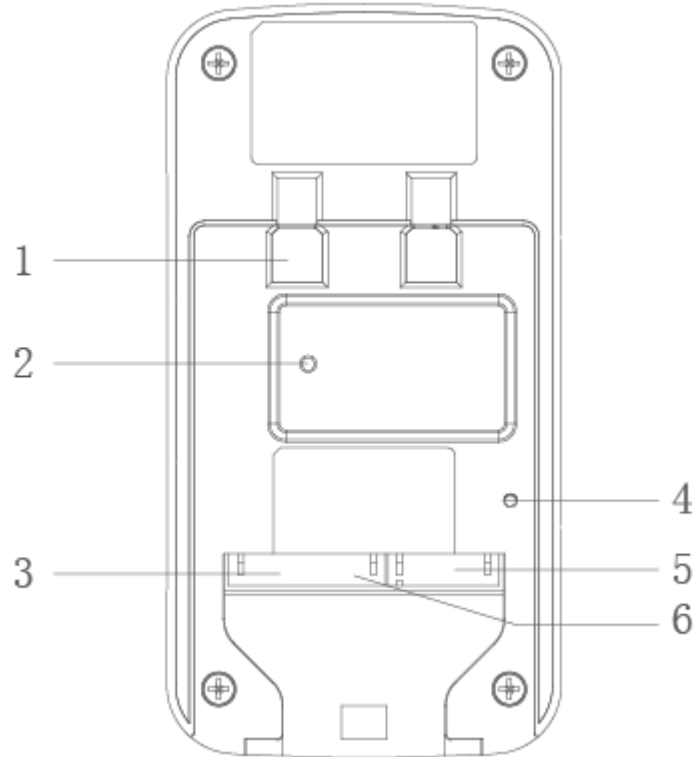

Figure 2-2

No.	Component Name	Note
1	Bracket Position	Bracket used to fix device and wall.
2	Vandal-proof Switch	When villa VTO is forced to leave wall, it will alarm and send alarm to MGT center.
3	Alarm Input/output Interface	1-ch alarm input.
4	RESET Key	<ul style="list-style-type: none"> • Shortly press this key to config reset WIFI. • Long press this key for 10s, system will restore default settings.
5	RJ45 Interface	Standard Ethernet cable, support POE power.
6	Power Input Interface	DC 12V input, support 9V-26V wide voltage, with anti-reverse connection.

Chart 2-2

3 Networking Scene

Villa VTO networking scene is in Figure 3-1.

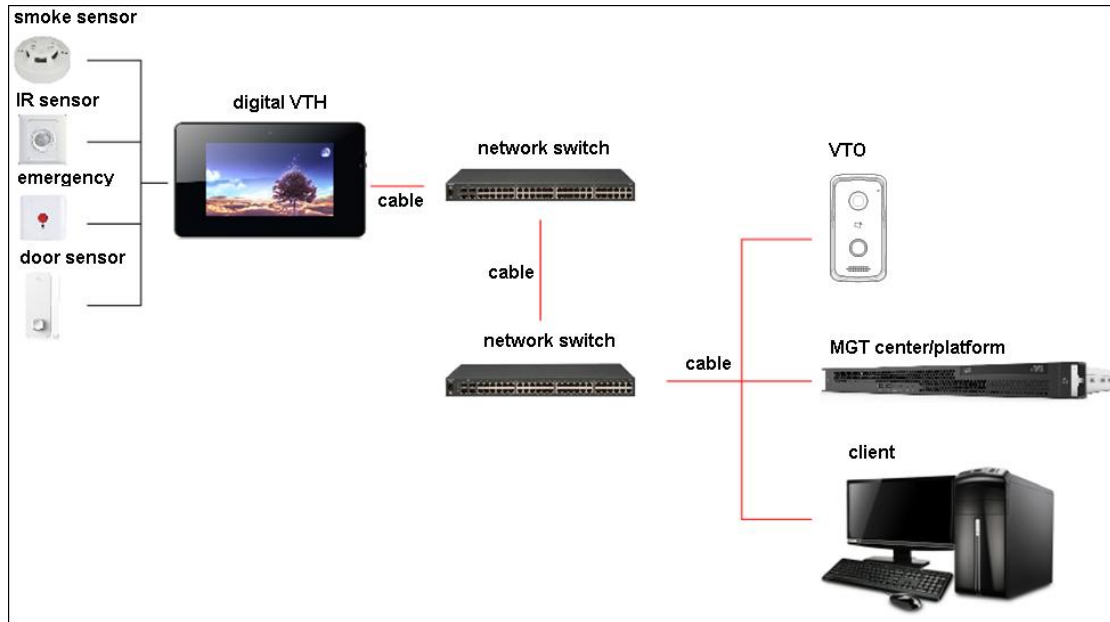

Figure 3-1

4 Installation and Debug

4.1 Device Wiring

Device wiring is in Figure 4-1.

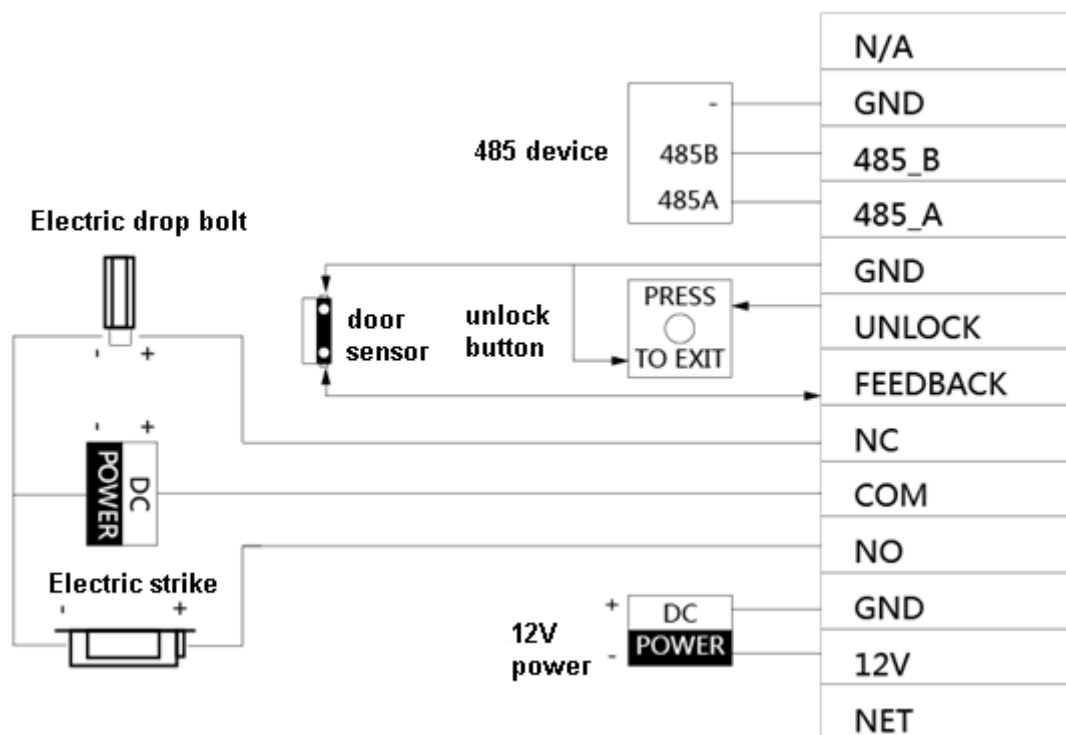

Figure 4-1

4.2 Device Installation

Warning:

- Avoid installation in poor environment, such as condensation, high temperature, oil stain, dust, corrosion or direct sunlight.
- Project installation and debugging must be done by professionals. Please do not open the device in case of failure, and please contact after sales service.

4.2.1 Screw

For installation, please use screw according to Chart 4-1.

Component Name	Illustration	Quantity
M4×30 cross pan head machine screw		2

Chart 4-1

4.2.2 Installation Step

VTH installation is in Figure 4-2.

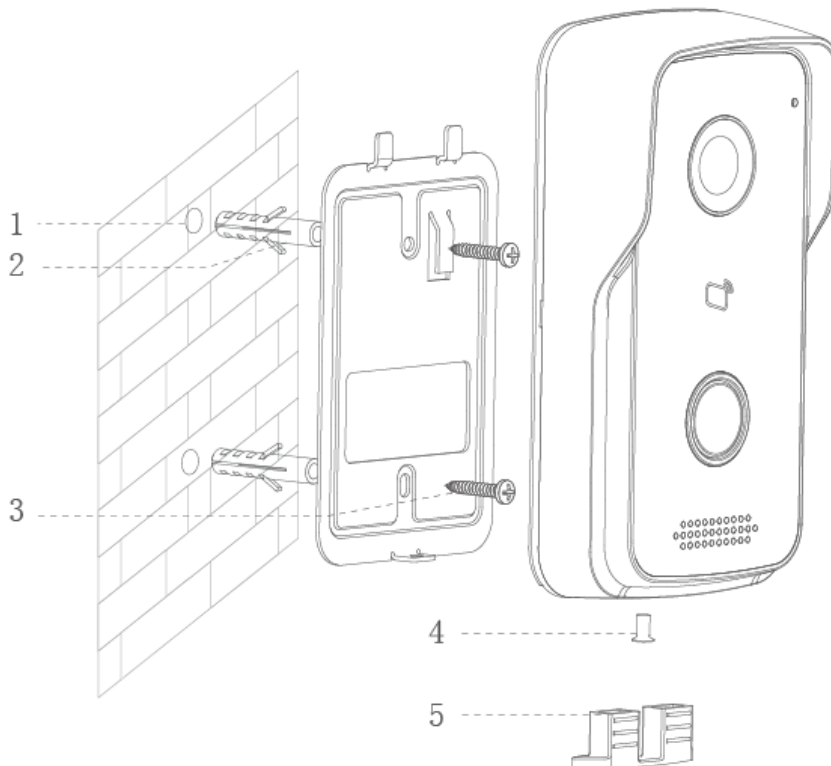

Figure 4-2

Steps:

- Step 1. According to position of bracket, dig hole on installation surface (such as wall).
- Step 2. Insert expansion bolt in hole you just dug.
- Step 3. Fix bracket on designated position with screw.
- Step 4. Fix device on bracket with screw.
- Step 5. Install tail sealing element at device tail. Use two M4×30 screw pan head machine screw to fix bracket on 86 box.

Note:

The recommended distance from device center to ground is 1.4m~1.6m.

4.3 Debug Device

4.3.1 Before Debugging

Warning:

- Debugging personnel shall be familiar with related materials, know device installation, wiring and usage.
- Debugging personnel check whether circuit has short circuit or open circuit or not. Make sure circuit is normal, plug device to power.
- After debugging end, clear up site (handle plugs, fix device and etc.)

Villa VTO default IP address is 192.168.1.110. Before you use the VTO, you must modify its IP to be in the same network segment with the VTH.

Step to debug:

Step 1. Connect device to power, and power up.

Step 2. In PC browser, enter device default IP address 192.168.1.110. See Figure 4-3.



Figure 4-3

Step 3. Enter username and password.

Note:

Default username is "admin". Default password is "admin". Please refer to Ch 5.2.4.1 for setup.

After modification is finished, WEB page will restart and go to new IP address.

4.3.2 Debug Device

Make VTH5221D an example here:

Step 1. Plug device to power.

Step 2. In homepage, long press Settings for 6 seconds. Device pops up Password Verification box.

Step 3. Enter project setup password which is 002236 by default.

Step 4. Press Net Set to connect VTH.

- Wireless:

If the VTH supports WI-FI, you can select wireless connection.

1. Select Wireless, open WLAN, view available WI-FI. See Figure 4-4.

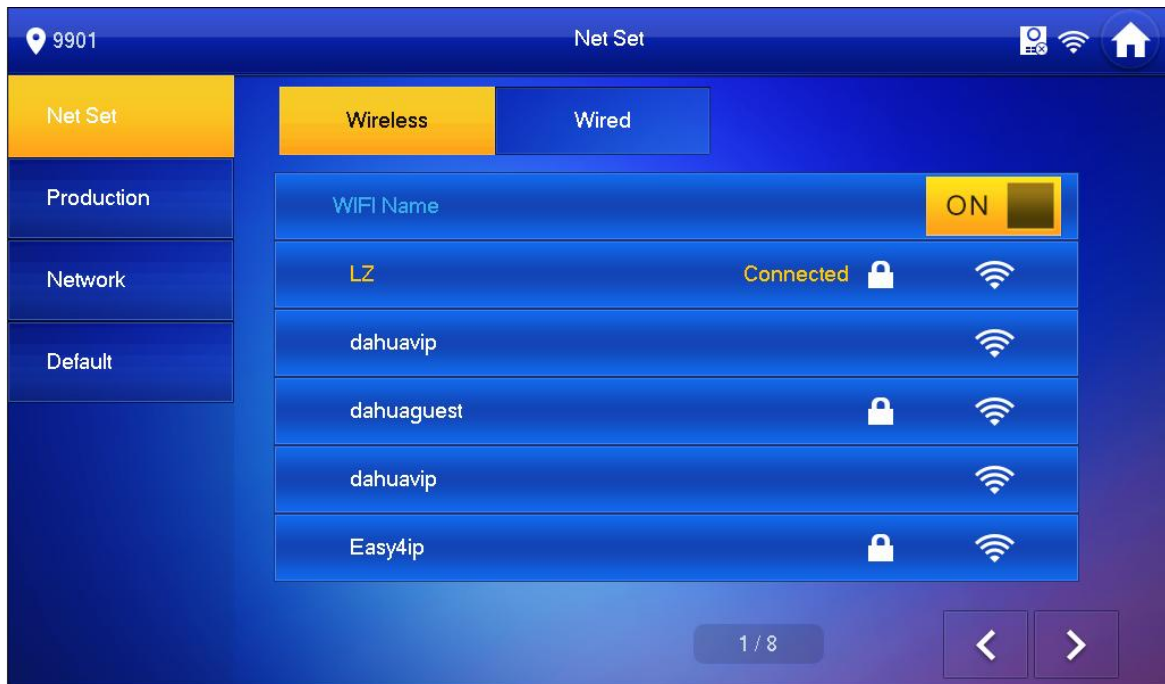



Figure 4-4

2. Select WI-FI you want to connect, and in pop-up WLAN connection window, enter WI-FI password.

3. Press OK.

Now device interface shows  at the upper-right corner which means wireless connection is successful.

- Wired:

1. Select Wired. See Figure 4-5.

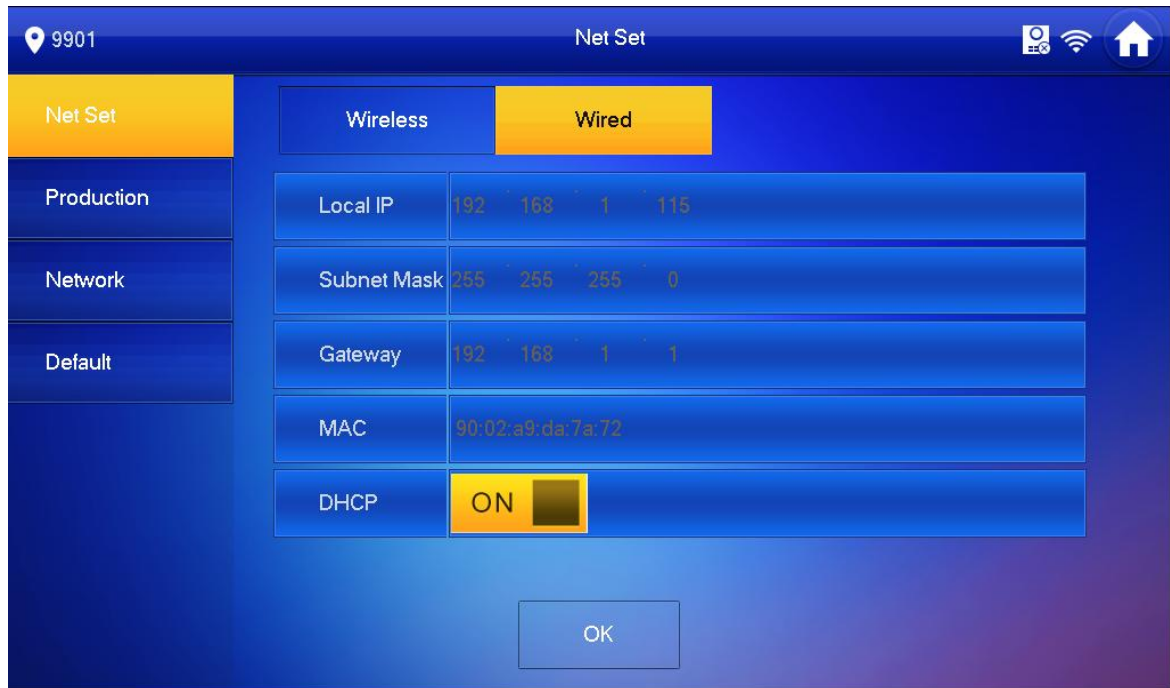



Figure 4-5

2. Enter VTH Local IP, Subnet Mask and Gateway.
3. Press OK.

Now device interface shows  at the upper right corner which means wired connection is successful.

Note:

You also can enable DHCP to auto gain VTH IP, subnet mask and gateway and press OK to complete wired connection.

Step 5. Press Production to config VTH room no.

Warning:

VTH room no. must match VTH short no. on WEB of corresponding VTO. Please refer to Ch 5.2.3.

- If you want to set this VTH to be master VTH, then you shall select Master. Fill in room no., press OK to save, see Figure 4-6.

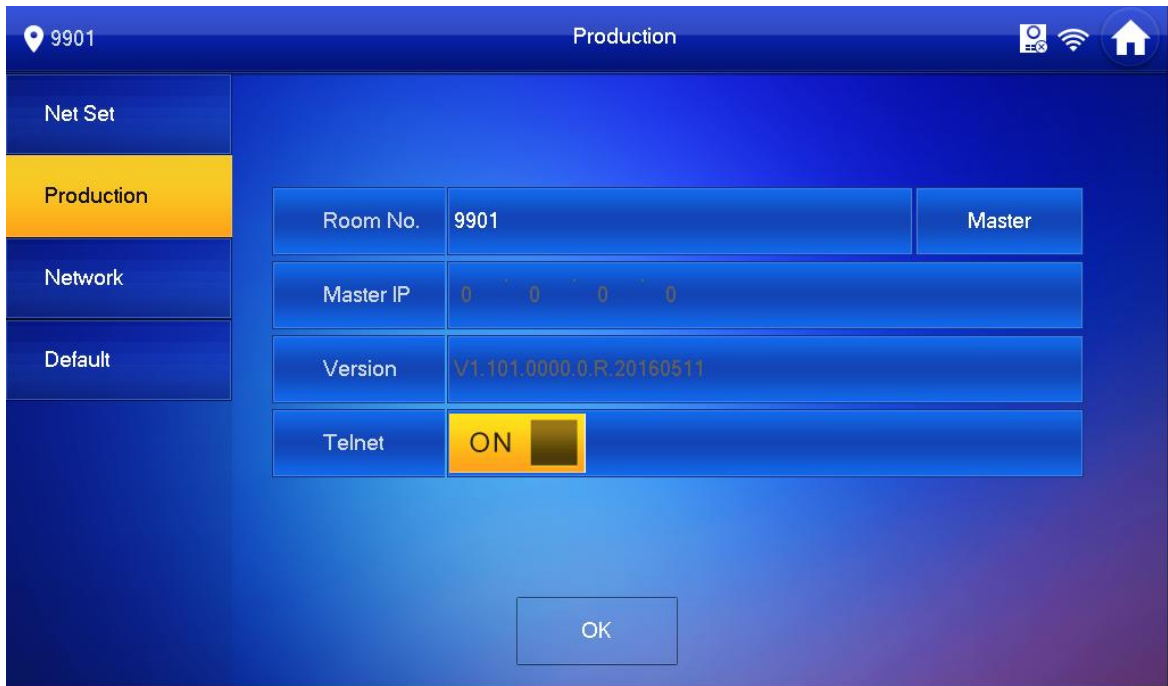

Figure 4-6

- If you want to set this VTH to be extension VTH, then you shall select Extension. Fill in user config info for extension to auto sync with master, such as room no. and master IP. See Figure 4-7.

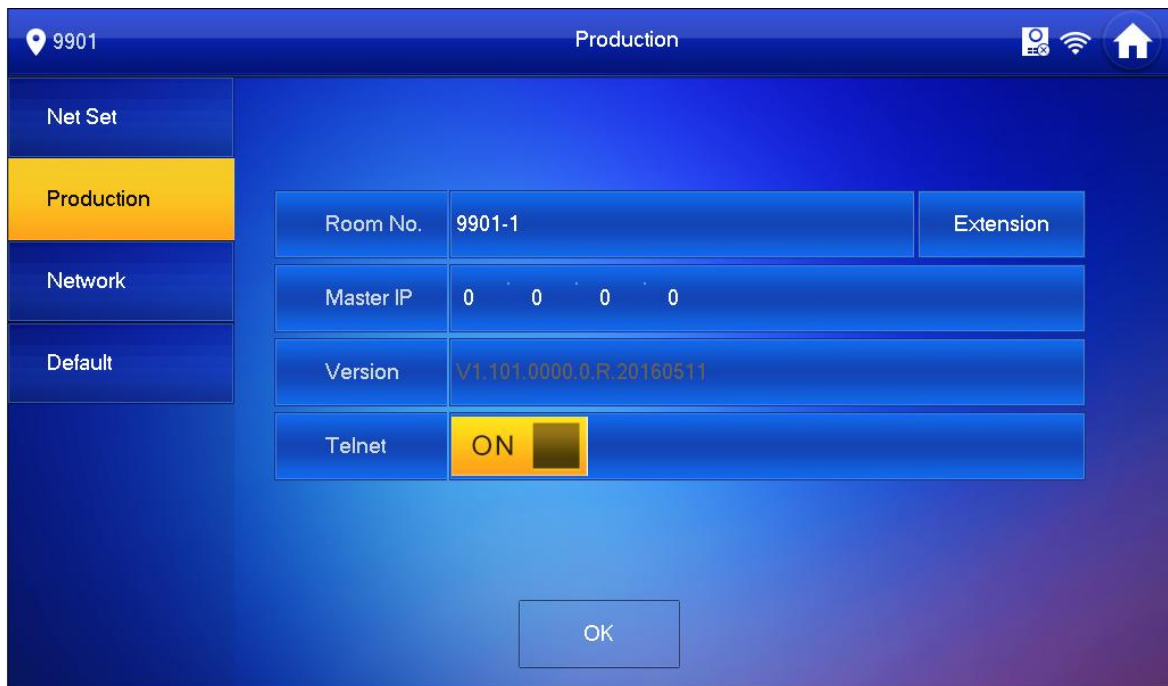

Figure 4-7

4. Press OK to save config.

System pops up prompt interface which means config is successful.

Note:

Telnet server is ON, debugging personnel can view VTH config via telnet+IP.

Step 6. Press Network to config VTO info.

Warning:

Before config, please make sure VTO is plugged to power and is in the same segment with VTH.

1. Fill in VTO name, master VTO IP address, set enable status to ON, see Figure 4-8.



Figure 4-8

2. Fill in VTO name, and extension VTO IP address, select device type, set enable status to ON.

The device supports n19 units of extensions, and you can press to page down to add more extensions.

4.3.3 Successfully Debug

On VTO dial VTO room no. to call VTH. VTH pops up monitoring video and operation buttons, see Figure 4-9.

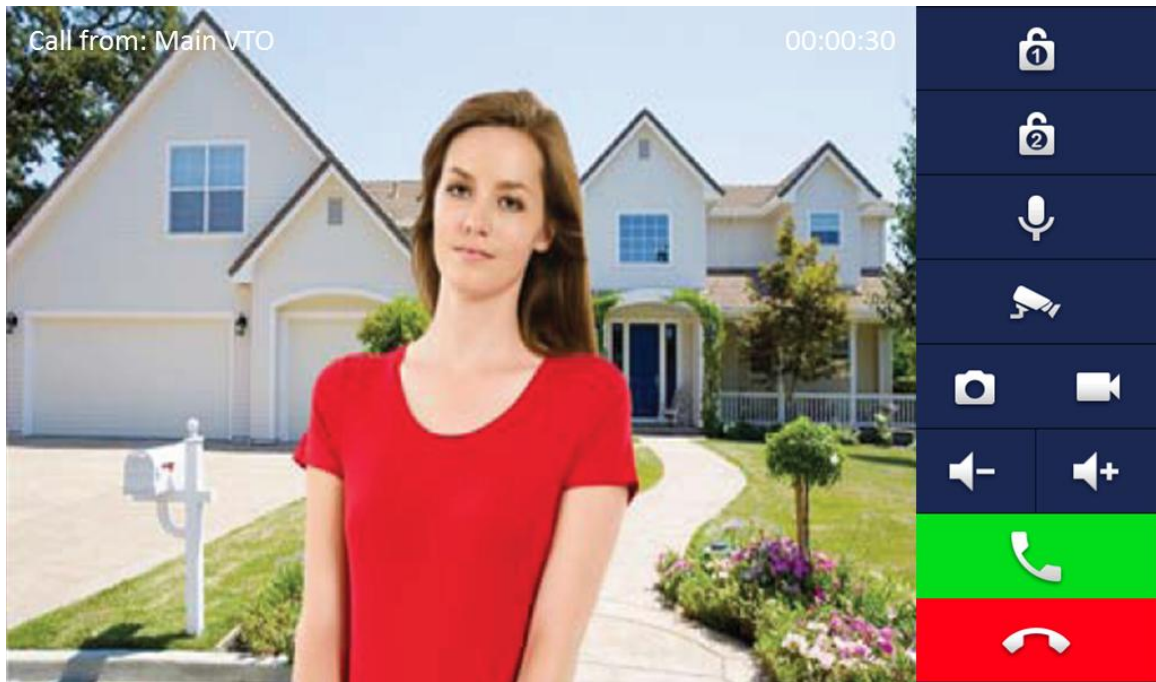





Figure 4-9

Icon	Icon Name	Note
	Unlock 1	VTO config electric control lock, press , unlock.
	Unlock 2	If this VTO has 485 expansion interface, it can expand electric control lock or door sensor lock, after successfully matching with VTH, press , unlock.
	MIC	Press , turn off MIC volume.
	IP Camera	Press , select IPC video of monitoring favorites.
	Snapshot	Press , to snapshot. Note: When SD card is not installed, this button is grey.
	Record	Press , record ; call ends, press , end recording. Records are stored to SD card of this VTH,

Icon	Icon Name	Note
		if full, it overwrites from the earliest record. Note: When SD card is not installed, this button is grey.
	Volume	Adjust call volume.
	Accept Call	-
	Hang up	-

5 Web Config

This chapter introduces VTO WEB interface and its parameters, and how to configure them.

5.1 WEB Login and Logout

5.1.1 Login

Step 1. In PC browser, enter device default IP address 192.168.1.110. See Figure 5-1.

Note:

Default username is “admin”. Default password is “admin”. Please refer to Ch 5.2.4.1 for setup.



Figure 5-1

Step 2. Enter username and password.

Note:

Default username is “admin. Default password is “admin”. After first time login, please change password for security reasons. Please refer to Ch 5.2.6.3.

Step 3. Click Login.

5.1.2 Logout

Step 1. Select Logout>Logout>Logout. See Figure 5-2.

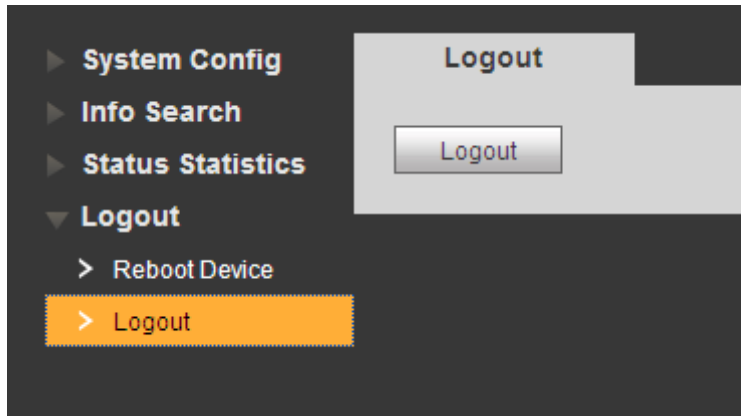

Figure 5-2

Step 2. Click Logout.

System exits WEB interface, return to login interface. You can go to Logout>Reboot Device>Reboot Device interface, click Reboot Device to restart.

5.2 System Config

5.2.1 Local Config

In Local Config interface, you can view VTO model, version info and etc.

5.2.1.1 Local Config

In System Config>Local Config>Local Config interface, you can set light sensor, storage point, reboot date and etc. See Figure 5-3 and Chart 5-1.

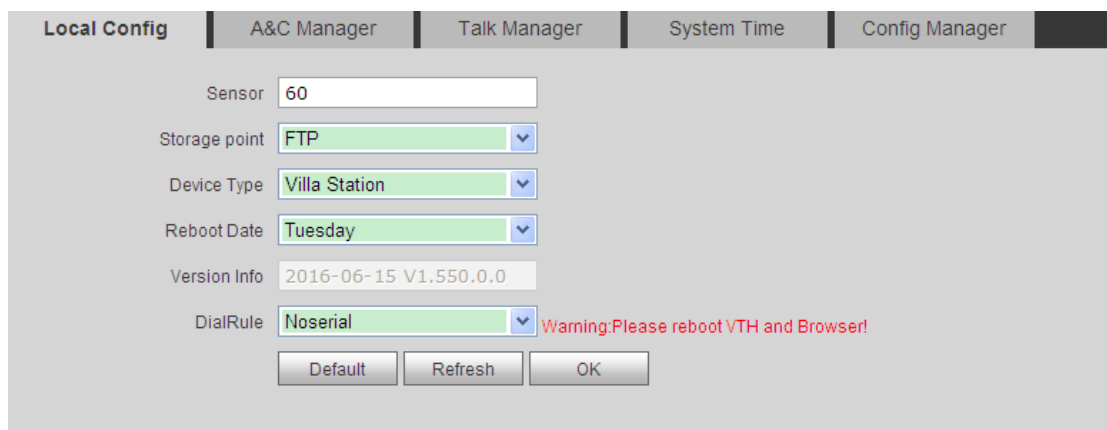

Figure 5-3

Parameter	Note
Sensor	Set compensation light threshold.
Storage Point	Storage path of record and picture, you can select FTP or SD card.

	Please refer to Ch 5.2.4.2 for FTP setup.
Device Type	Display device type. Now it is "villa station".
Reboot Date	On the set date, device will automatically reboot. Default is 2:00 a.m. Tuesday.
Version Info	Display device version info.
Dial Rule	There are serial and non-serial.
Default	Only restore current Local Config page to default settings.
Refresh	Click Refresh to refresh current interface.
OK	Click OK to save.

Chart 5-1

5.2.1.2 A&C Manager

A&C Manager mainly controls unlock responding interval time, unlock period and door sensor check time.

Go to System Config>Local Config>A&C Manager. See Figure 5-4 and Chart 5-2.

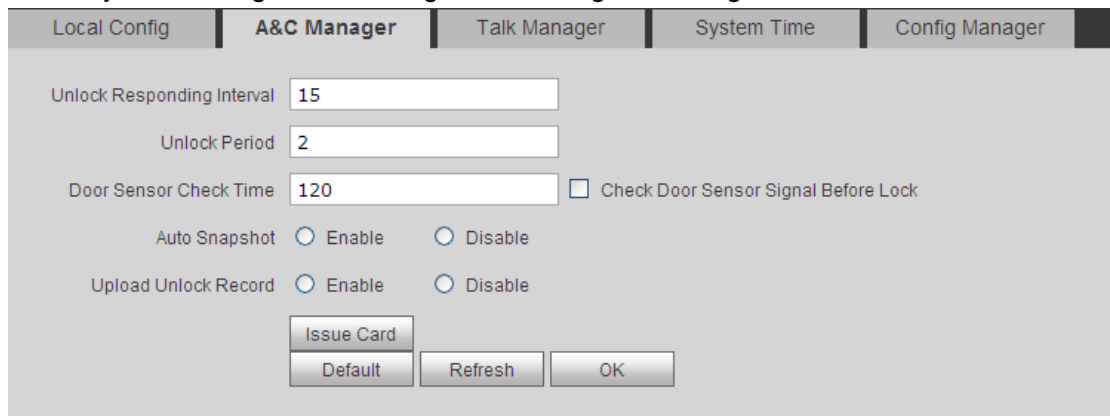

Figure 5-4

Parameter	Note
Unlock Responding Interval	The interval between current unlock and next one, unit is second.
Unlock Period	Period door remains unlocked, unit is second.
Door Sensor Check Time	When only use door sensor, check "Check Door Sensor Signal Before Lock", Set "Door Sensor Check Time" to enable it.
Check Door Sensor Signal Before Lock	When door remains unlocked over set door sensor check time, it alarms.
Auto Snapshot	Select Enable, when you swipe card, it auto snapshot two pictures and upload them to FTP or SD card.
Upload Unlock Record	Select Enable, upload unlock record. You can view in Info Search>Unlock Record> VTO Unlock Record.
Issue Card	Authorize IC card unlock right, convenient for user to

	unlock door; support up to 10000 IC cards. Please refer to Ch 5.2.1.3.
Default	Only restore A&C Manager page to default settings.
Refresh	Click Refresh to refresh current interface.

Chart 5-2

5.2.1.3 Issue Card

Note:

Before you issue card, please add VTH first, refer to Ch 5.2.3.1.

Step 1. Select System Config>Local Config>A&C Manager.

Step 2. Click Issue Card, and place IC card close to card swiping area on VTO. Sysrem shows card no. Info interface.

Step 3. Enter the IC card's corres[ondiong username and room no., Click OK.

Note:

Fill in room no. Which must match info on VTH.

Step 4. Click Confirm Issue to complete card issuing.

Now you can go to System Config>Indoor Manager>Digital Indoor Station Manager,

click  to view.

5.2.1.4 Talk Manager

Go to System Config>Local Config>Talk Manager, see Figure 5-5.

The device supports talk management and you can enable and disable upload of talk call record, message and auto snapshot.

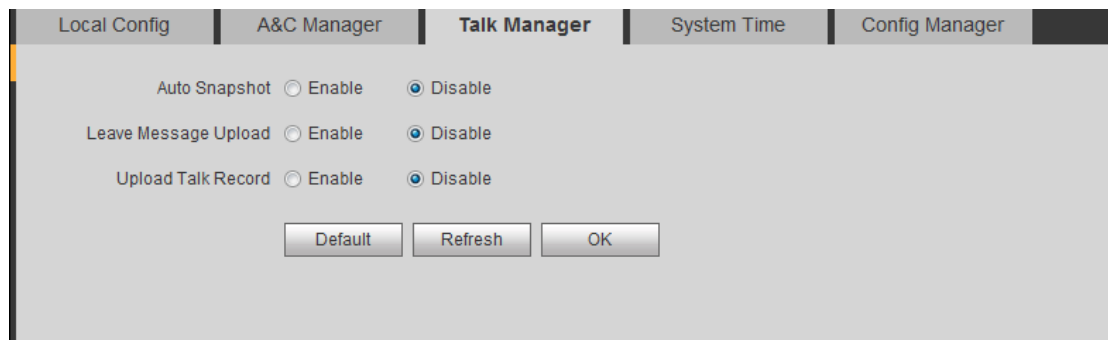

Figure 5-5

Parameter	Note
Auto Snapshot	Select Enable, when it calls, auto snapshot three pictures, and upload to FTP or SD card.

Parameter	Note
Leave Message Upload	<p>Select Enable, villa VTO calls VTH, no one answers, caller can leave a message on VTO.</p> <p>Message will be stored in SD card, and can be viewed on VTH.</p> <p>Note:</p> <p>If VTH sets message time to 0 seconds, then message is not allowed. If message time is set other than 0, when no one answer call from VTO, it will ask if you want to leave a message.</p>
Upload Talk Record	Select Enable, upload call record, you can go to Info Search >Unlock Record >Call Record to view.

5.2.1.5 System Time

Go to System Config>Local Config>System Time, see Figure 5-6.

Here you can set date format, time format(24-hour and 12-hour), and input system date and time. You can also click on Sync PC to synchronize system time with PC time. You also can set DST start time.

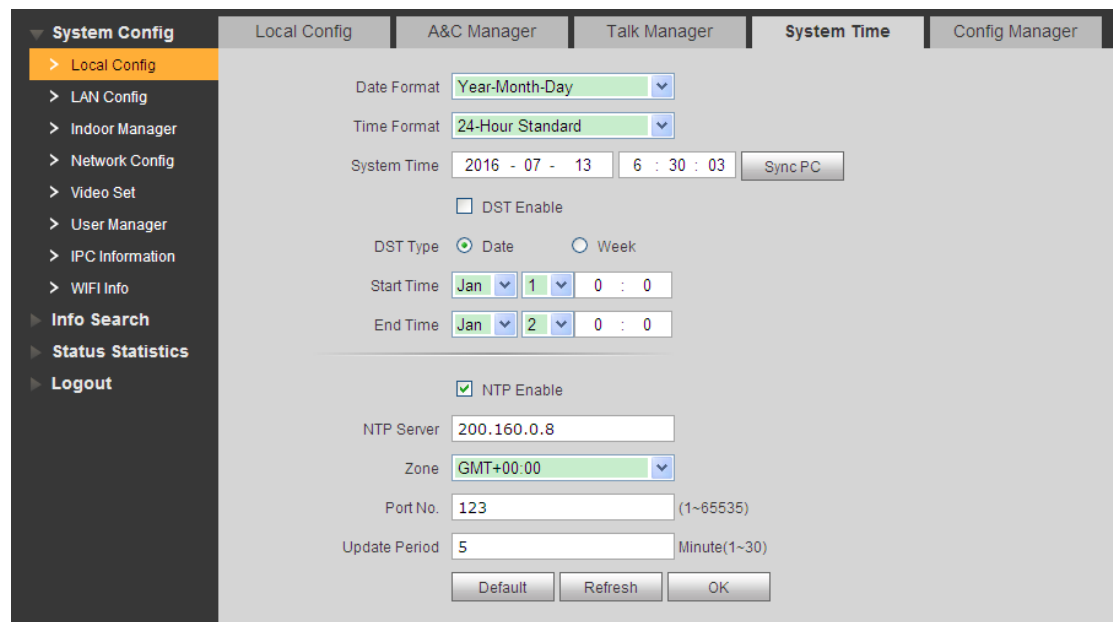

Figure 5-6

Parameter	Note
Date Format	Set date display.
Time Format	Set time display, there are 12-hour and 24-hour modes.
System Time	Set system display time.
Sync PC	Click "Sync PC", to sync system time with local PC.

Parameter	Note
DST Enable	Check "DST Enable" box, to enable DST. If you locate in place using DST, you can set DST accordingly. You can select week mode or date mode to start and end DST.
DST Type	
Start Time	
End Time	
NTP Enable	Check "NTP Enable" box, to enable NTP server time sync function. You can enter IP, zone, port no. and interval of PC where you installed NTP server to set NTP.
NTP Server	
Zone	
Port No.	
NTP Update Period	
Default	Click "Default", to restore default settings in this tab.
Refresh	Click "Refresh" to refresh this page.

Chart 5-3

5.2.1.6 Config Manager

Go to System Config>Local Config>Config Manager, see Figure 5-7.

You can import and export configuration, or restore default setup.

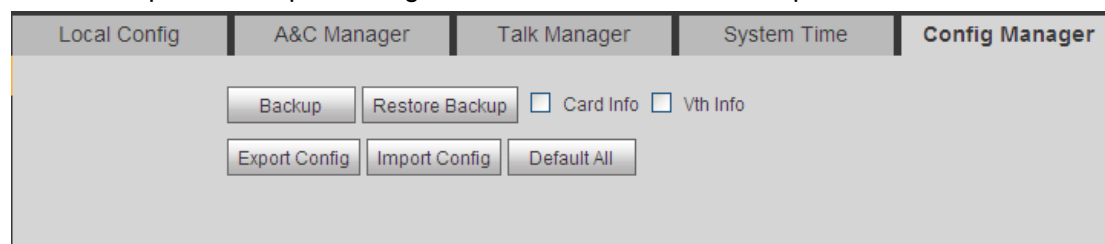
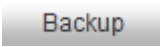

Figure 5-7

Parameter	Note
Backup	Check "card no.", "VTH info", and click  , so you can back up card no. and VTH info.
Restore Backup	Restore backup card info or VTH info. <ul style="list-style-type: none"> ● During usage, if villa VTO is restored to default or card info is abnormal, you can check Card Info box and click Restore Backup to restore card info. ● During usage, if you miss-modify VTH info, you can check VTH info box and click Restore Backup to restore VTH info. <p>Warning: Every half an hour, VTO auto saves card no. and VTH info in the</p>

	system, so if you want to restore card info or VTH info, you must operate within this time limit.
Export	Export config file (Config.backup)
Import	Import config file.
Default	Restore all parameters to default status.

Chart 5-4

5.2.2 LAN Config

Go to System Config>LAN Config>LAN Config, see Figure 5-8.

Here you can register VTO to center and set how to call center. Please refer to Ch 5.1.1.

Figure 5-8

Parameter	Note
Building No.	Set villa VTH building no. and unit no.
Building Unit No.	
VTO No.	Default is 6901. If connects to more than one VTO, enter 6901, 6902, 6903 and so forth.
Max Extension Index	1 VTH supports 5 extensions, and fill in extension according to actual condition. Warning: When number of extension changes, you shall reboot VTH, and configure VTH again.
Group Call	Check "Group Call" box to call all VTHs, in this room.
MGT Center IP Address	Enter IP address and port no. of MGT center, check "Register to

Parameter	Note
Register to MGT Center	MGT center” box.
MGT Port No.	
Call VTS Time	Set period of call button on device to call MGT center.
Call VTS or Not	Check “Call VTS or Not” box, to enable call MGT center function via button on villa VTO during the set period instead of calling VTH.
No Answer Transfer to MGT Center	Select Enable, when villa VTO calls VTH and no one answer, it will call MGT center. Note: If you enable this function, and message time setup of VTH is not 0, then when no one answers VTO call, it will call MGT center and will not enter message.
Default	Click “Default”, to restore setting in this page to default.
Refresh	Click “Refresh” to refresh this page.

Chart 5-5

5.2.3 Indoor Manager

In Indoor Manager interface, you can add, delete and modify VTH (digital indoor station).

5.2.3.1 Add VTH

Villa VTO only supports to add 1 VTH. Any new VTH will replace current VTH.

Step 1. In tab, select System Config>Indoor Manager>Digital VTH Manager.

Step 2. Click .

Step 3. Fill in digital VTH basic info. See Figure 5-9.

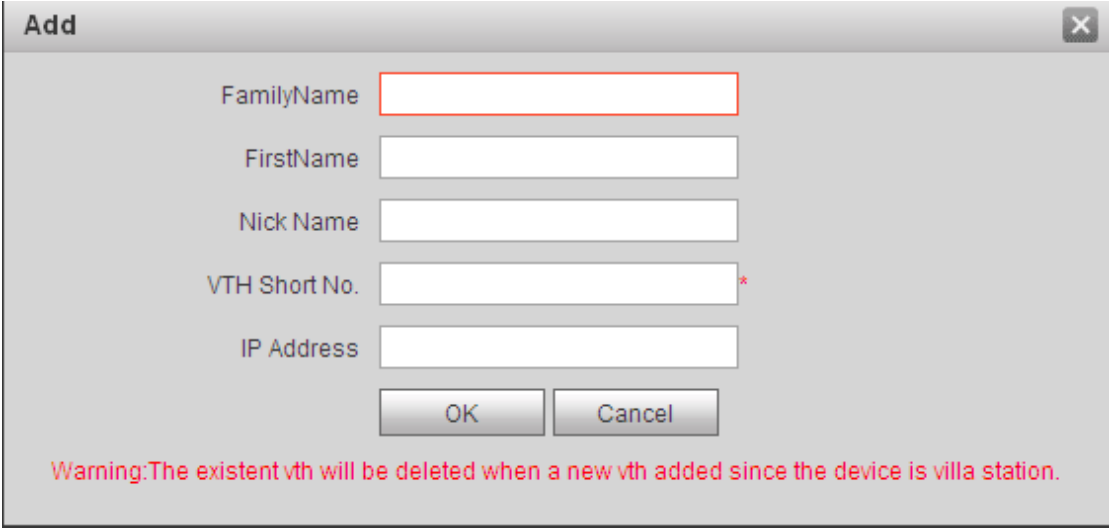

Add

FamilyName

FirstName

Nick Name

VTH Short No. *

IP Address

OK Cancel

Warning:The existent vth will be deleted when a new vth added since the device is villa station.

Figure 5-9

Note:

Parameters with * are mandatory.

Parameter	Note
Family Name	Set username and nick name of VTH.
First Name	
Nick Name	
VTH Short No.	Known as VTH room no. Note: VTH short no. is composed of 4 digits of number. The first two digits have range of 01~99. The last two digits have range of 01~16.
IP Address	VTH IP address.

Chart 5-6

Step 4. Click .

System displays interface when VTH is added. See Figure 5-10.

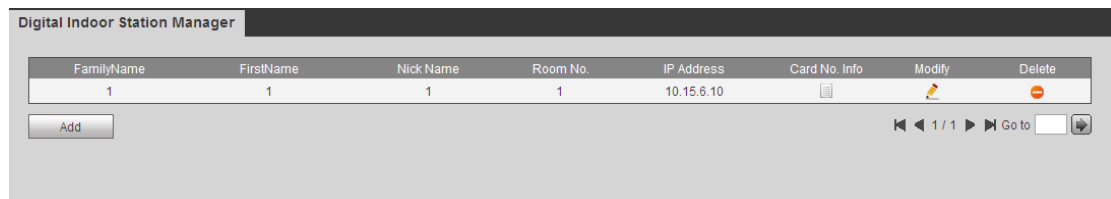



Figure 5-10

5.2.3.2 Modify VTH

- Click , in pop-up modification page modify VTH info.
 1. When you modify digital VTH, you can only modify name and nickname.
 2. When you modify analog VTH, you can only modify name, nickname, distributor address and distributor port.
- Click , delete digital VTH.

5.2.3.3 View Card Info

Card authorization is in Ch 5.2.1.3.

Click  to view all authorized card under the VTH. See Chart 5-7.



Parameter	Note
Card ID	Show IC card number, username and VTH room no.
Card Number	
Username	
Main Card	Check "main card" box, set this IC card to be main card. Note: Main card has card authorization function, and this device does not support.
Report Loss	When IC card is lost, click  to report loss. Lost IC card cannot unlock door.
Modify	Click  , you can modify username under this IC card.
Delete	Click  , you can delete this IC card.

Chart 5-7

5.2.4 Network Config

5.2.4.1 TCP/IP

Go to System Config>Network Config>TCP/IP, see Figure 5-11.

You can set local IP network parameter.

Step 1. Select System Config>Network>TCP/IP.

Step 2. Set local IP address, subnet mask and default gateway.

See [错误!未找到引用源。](#) .

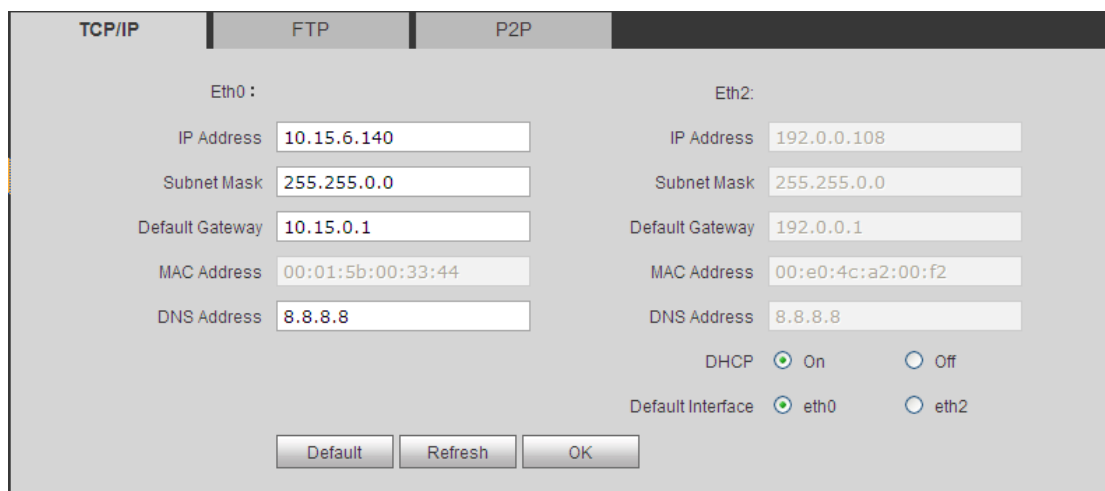

The screenshot shows the TCP/IP configuration interface with two columns for network interfaces: Eth0 and Eth2. Each column contains input fields for IP Address, Subnet Mask, Default Gateway, MAC Address, and DNS Address. Below these fields are radio buttons for DHCP (On/Off) and Default Interface (eth0/eth2). At the bottom, there are buttons for Default, Refresh, and OK.

Parameter	Eth0	Eth2
IP Address	10.15.6.140	192.0.0.108
Subnet Mask	255.255.0.0	255.255.0.0
Default Gateway	10.15.0.1	192.0.0.1
MAC Address	00:01:5b:00:33:44	00:e0:4c:a2:00:f2
DNS Address	8.8.8.8	8.8.8.8
DHCP	<input checked="" type="radio"/> On	<input type="radio"/> Off
Default Interface	<input checked="" type="radio"/> eth0	<input type="radio"/> eth2

Figure 5-11

Step 3. Click .

After you have modified IP address, WEB page will reboot and go to the new IP address page.

Parameter	Note
IP Address	Enter corresponding number to change IP address.
Subnet Mask	According to actual condition, set subnet mask which prefix is number, enter 1~255, subnet mask prefix has a specific network link, which includes one layer structure in general.
Default Gateway	According to actual condition, it must be in the same segment with IP address.
MAC Address	Display device MAC address..
DNS Address	Enter rules DNS server IP address.
DHCP	Enable, auto get IP function.
Default Gateway	<ul style="list-style-type: none"> ● Wired, by default select Ethernet card 1. ● Wireless, by default select Ethernet card 2.
Default	Click "Default", restore all parameters in the page to default.
Refresh	Click "Refresh", refresh current page.

Chart 5-8

5.2.4.2 FTP

FTP server is used to store record, snapshot picture and etc. User can login FTP server to view and get photo or image.

Warning:

You must purchase or download FTP tool, and install the software into PC.

Step 1. You can go to System Config>Network>FTP, to set local FTP network parameter.

See Figure 5-12.

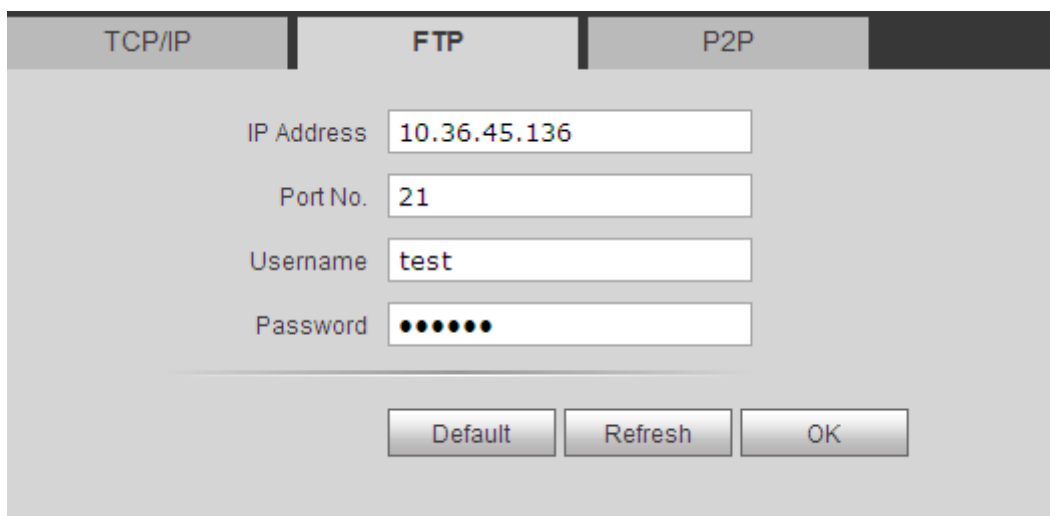

Figure 5-12

Step 2. Configure parameters, see Chart 5-9.

Parameter	Note
IP Address	IP address of host where FTP server is installed.
Port No.	Default is 21.
Username	Access FTP server username and password.
Password	

Chart 5-9

Step 3. Click OK.

5.2.4.3 P2P

Step 1. You can go to System Config>Network>P2P interface. See Figure 5-13.



Figure 5-13

Step 2. Select to enable P2P server.

Step 3. Select P2P server.

Step 4. Click OK.

After setup is complete, “status” becomes “online” which means P2P registration is successful. You can scan QR code below to add device on mobile phone client.

5.2.5 Video Set

5.2.5.1 Video Set

You can go to System Config>Video Set interface to set video and audio.

Step 1. Select System Config>Video Set.

Step 2. Adjust video parameter. See Figure 5-14.

Note:

If you cannot see video in window, please install plug-in first.

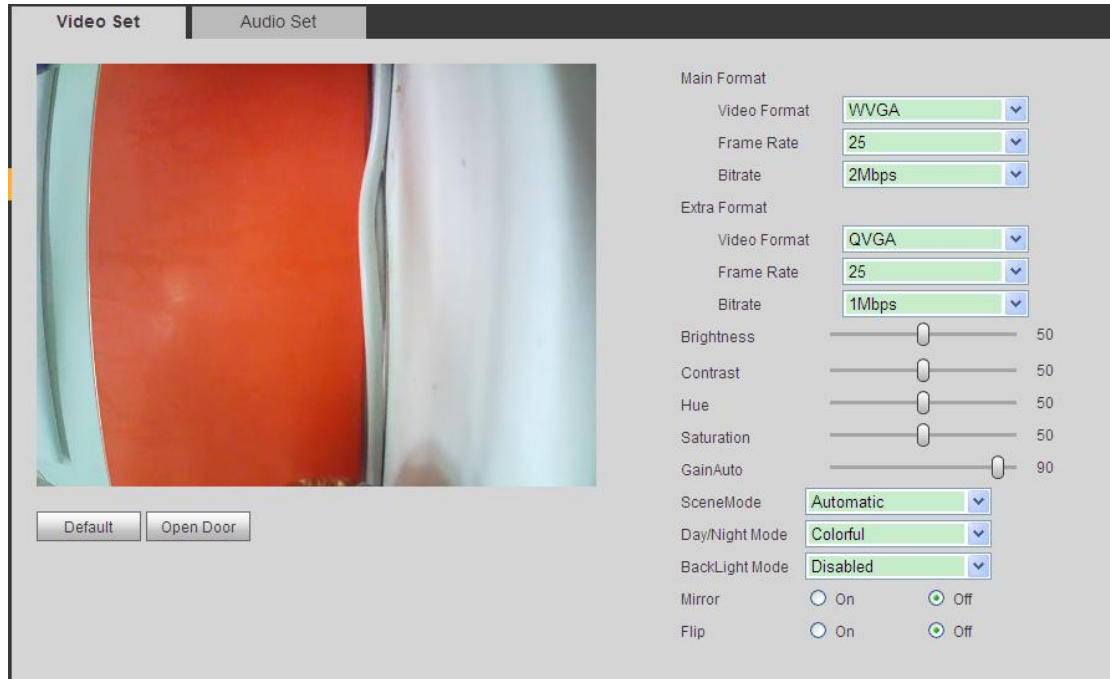

Figure 5-14

Parameter		Note
Main Format	Video Format	Adjust video resolution, includes 720P, WVGA and D1. <ul style="list-style-type: none"> ● 720P: 1280×720. ● WVGA: 800×480. ● D1: 720×576.
	Frame Rate	Adjust video frame rate to be 3, 25 and 30.
	Bit Rate	According to actual device input network, select bit rate to be 256Kbps, 512Kbps, 1Mbps, 2Mbps and 3Mbps.
Extra Format	Video Format	Adjust video resolution to be WVGA, D1 and QVGA. <ul style="list-style-type: none"> ● WVGA: 800×480. ● D1: 720×576. ● QVGA: 320×240.
	Frame Rate	Adjust video frame rate to be 3, 25 and 30.
	Bit Rate	According to actual device input network, select bit rate to be 256Kbps, 512Kbps, 1Mbps, 2Mbps and 3Mbps.
Brightness		Adjust video brightness, recommended value is 40~60, range is 0~100.
Contrast		Adjust video image contrast, recommended value is 40~60, range is 0~100.
Saturation		Adjust color saturation, recommended value is 40~60,

Parameter	Note
	range is 0~100.
Saturation	Adjust color saturation, recommended value is 40~60, range is 0~100.
Gain	Gain limit of video basic parameter.
Scene Mode	Select mode: automatic, sunny, night and etc.
Day/Night Mode	Include: colorful, automatic and Black White .
Back Light Mode	Include: Disabled, backlight, WDR, HLC.
Mirror	Make image displayed in mirror.
Flip	Display image in flip.
Default	Reset video effect and volume to default.
Unlock	Unlock via web.

Chart 5-10

5.2.5.2 Audio Set

Go to System Config>Video Set>Audio Set interface, you can slide bar to adjust MIC volume and VTO speaker volume, see Figure 5-15.

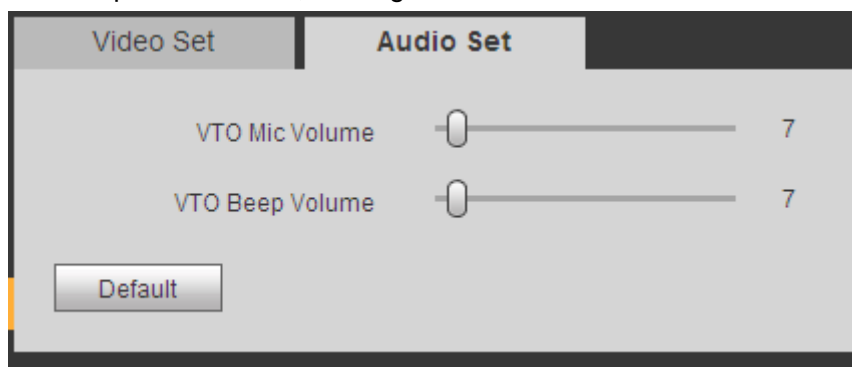

Figure 5-15

5.2.6 User Manager

You can add, delete user or modify user password.

5.2.6.1 Add User

- Step 1. Select System Config>User Manager, system enters User Manager interface.
- Step 2. Click Add.
- Step 3. Configure user info to add. See Figure 5-16.

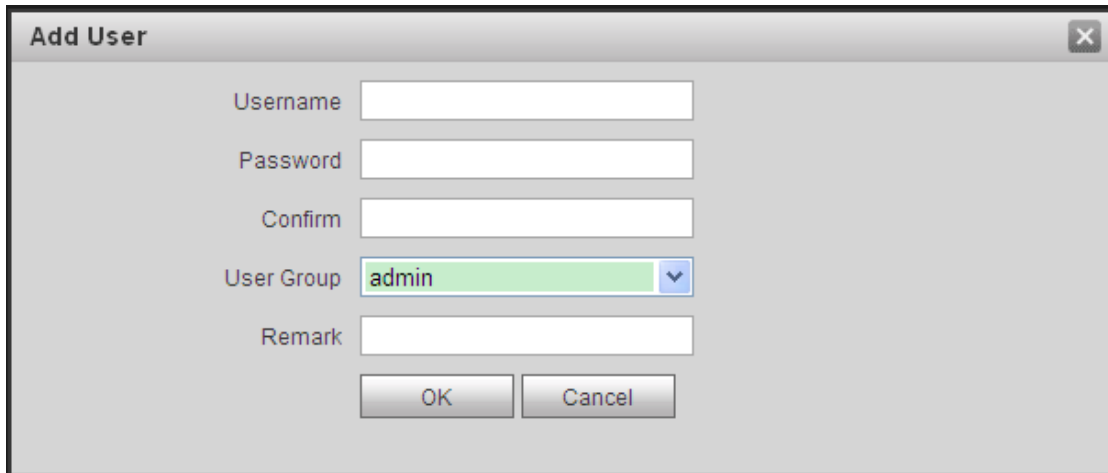
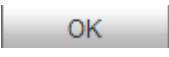

Figure 5-16

Step 4. Click . See Figure 5-17.

Only when you login as admin, you can add, modify, delete and view user info in User Manage interface.

Current system supports two types of user:

- Admin has higher right who can view, edit, delete configured right.
- User only can view system config.

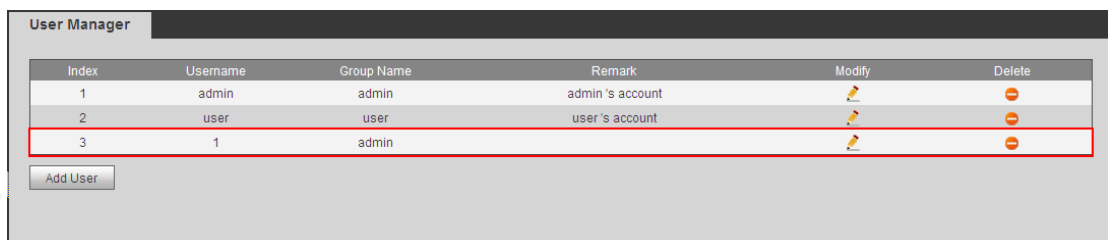



Figure 5-17

5.2.6.2 Delete User

Select user you want to delete, and click  to delete.

5.2.6.3 Modify User

Step 1. Select user who you want to modify his/her password, click . See Figure 5-18.

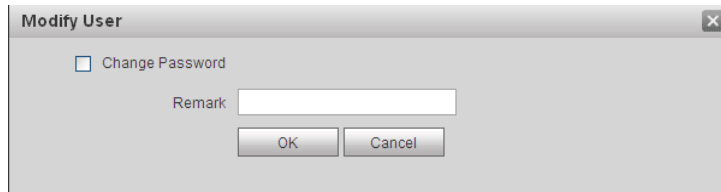

Figure 5-18

Step 2. Check Change Password box.

System shows Old Password, New Password and Confirm Password.

Step 3. Configure interface parameter.

Step 4. Click OK.

5.2.7 IPC

If the VTH has configured with IPC info, you can view IPC video image via corresponding VTH. It supports up to 20 IPCs.

You can go to System Config>IPC info interface, view and modify all IPC info.

Step 1. Select System Config>IPC info.

Step 2. Click .

Modify IPC info. See Figure 5-19.

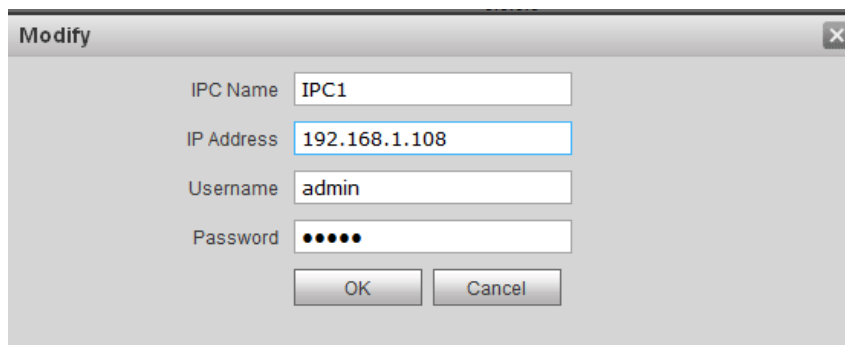

Figure 5-19

Step 3. Refer to Chart 5-11.

Parameter	Note
IPC Name	IPC name.
IP Address	IP address of IPC.
Username	Login username of password of IPC WEB.
Password	

Chart 5-11

Step 4. Click .

5.2.8 WIFI Info

Note:

Only some models support WIFI function.

To configure WIFI:

Step 1. Go to System Config>WIFI Info>WIFI Info.

Step 2. Click Open WLAN, and system searches and displays available WIFI, see Figure 5-20.

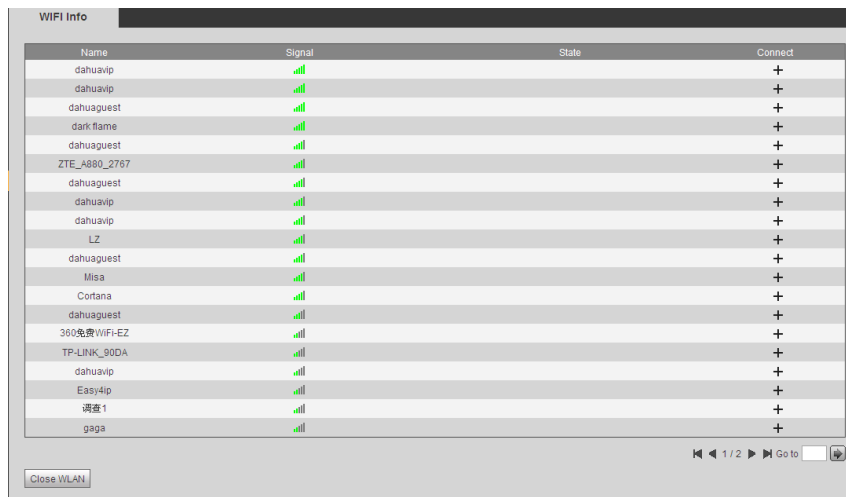

Figure 5-20

Step 3. Click **+** of WIFI you want to connect. System shows Connection interface, see Figure 5-21.

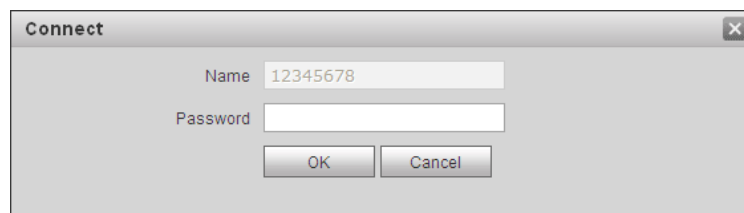

Figure 5-21

Step 4. Enter WIFI password, click OK to complete device WLAN connection.

Now System Config>Network Config>TCO/IP interface shows Ethernet card 2 connection.

5.3 Info Search

You can search and export VTP unlock, call and alarm record in Info Search interface.

5.3.1 Call History

You can search VTO call history in Call History interface, it stores up to 1024 records. See Figure 5-22.

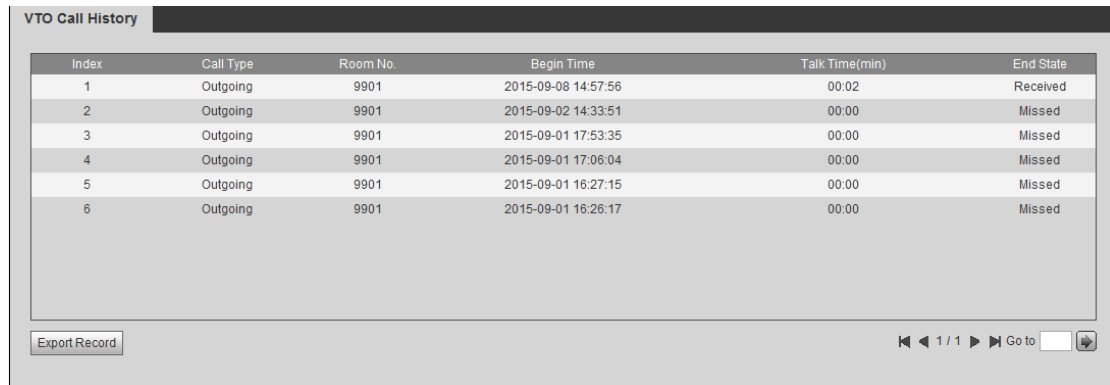

Index	Call Type	Room No.	Begin Time	Talk Time(min)	End State
1	Outgoing	9901	2015-09-08 14:57:56	00:02	Received
2	Outgoing	9901	2015-09-02 14:33:51	00:00	Missed
3	Outgoing	9901	2015-09-01 17:53:35	00:00	Missed
4	Outgoing	9901	2015-09-01 17:06:04	00:00	Missed
5	Outgoing	9901	2015-09-01 16:27:15	00:00	Missed
6	Outgoing	9901	2015-09-01 16:26:17	00:00	Missed

Export Record

1 / 1

Figure 5-22

5.3.2 Alarm Record

Go to Info Search>Alarm Record>Alarm Record interface. See Figure 5-23. You can search VTO alarm in Alarm Record interface, and it stores up to 1024 records.

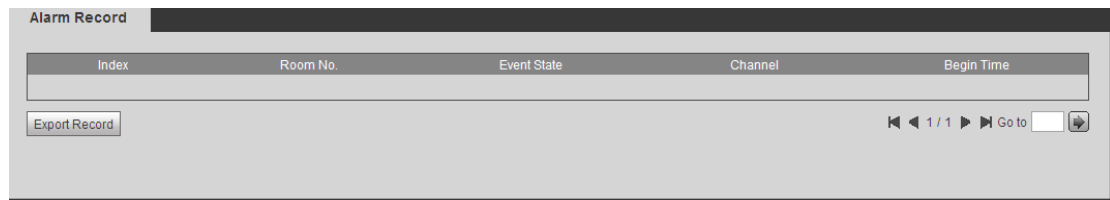

Index	Room No.	Event State	Channel	Begin Time
-------	----------	-------------	---------	------------

Export Record

1 / 1

Figure 5-23

Click Export Record button to export villa VTO alarm record.

5.3.3 Unlock Record

Go to Info Search>Unlock Record>VTO Unlock Record. See Figure 5-24. You can search VTO unlock records in Unlock Record interface, and it stores up to 1000 records.

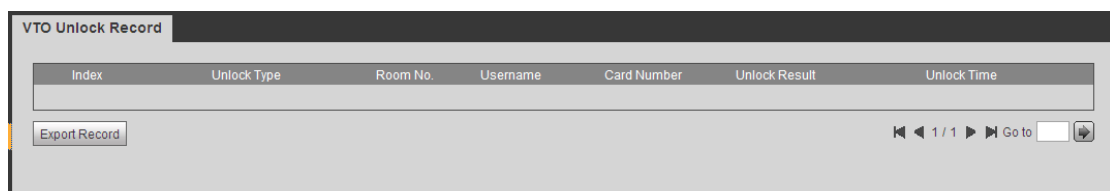

Index	Unlock Type	Room No.	Username	Card Number	Unlock Result	Unlock Time
-------	-------------	----------	----------	-------------	---------------	-------------

Export Record

1 / 1

Figure 5-24

Click Export Record button to export villa VTO alarm record.

5.4 Status Statistics

Warning:

If the added VTH is not online, then you go to Status Statistics>VTH Status interface, view VTH connection status, monitor status port no. and etc. See Figure 5-25.

In VTH status, you can view VTH connection status.

- Status

Offline: Connection between VTO and VTH is disconnected; you cannot call, monitor or talk.

Online: Connection between VTO and VTH is ready, you can call, monitor and talk.

- Monitor Status

Unmom: VTH is not monitoring.

Onmom: VTH is monitoring.

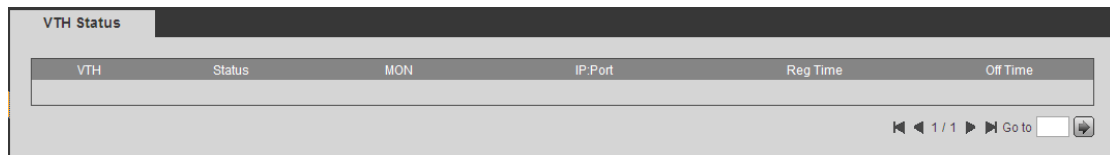

VTH	Status	MON	IP:Port	Reg Time	Off Time
-----	--------	-----	---------	----------	----------

Figure 5-25

6 Basic Function Introduction

Villa VTO supports unlock by card, one-click call MGT center and VTH, plus video talk with MGT center and VTH.

6.1 Monitor

Download mobile phone App and sign up, you can remotely view video of VTO. Please refer to Ch 5.2.4.3.

6.2 Call Function

Press call button on device, to call MGT center or VTH.
Please refer to Ch 5.2.2.

6.3 Unlock

Unlock by Card

At card swiping area on villa VTO, swipe authorized IC card, then you can unlock door after passing verification.

Please refer to Ch 5.2.1.3.

Unlock by Center

When center is called, calling or monitoring, center can remotely unlock door. VTO will return to standby interface after call ends or countdown stops.

Unlock by VTH

When VTH is called, calling or monitoring, VTH can remotely unlock door. VTO will return to standby interface after call ends or countdown stops.

6.4 Restore Backup

Please refer to Ch 5.2.1.6.

Appendix 1 Technical Specifications

Model	VTO2111D-WP	VTO2111D-W	VTO2111D
System			
Main Process	Embedded micro controller		
OS	Embedded Linux os		
Video			
Video Compression Standard	H.264		
Audio			
Audio Standard	G.711		
Input	Input		
Output	Output		
Talk	Talk		
Operation Mode			
Input	Mechanical keypad		
Alarm			
Input	1-ch unlock button, 1-ch door sensor feedback		
Output	1-ch relay output		
Front Camera	1.0 MP		
Network			
Ethernet	10M/100Mbps self-fit		
WIFI	Support	Support	Not support
Other Hardware Interface			
485 BUS	1-ch		
External TF Card Extension	Max support 64G		
Environment			
Power	DC 12V or standard POE	DC 12V	DC 12V
Water-proof	IP65 level		
Consumption	Standby ≤1W, work≤7W		
Dimension	135mm×70.4mm×34.4mm		

Note:

- **This manual is for reference only. Slight difference may be found in user interface.**
- **All the designs and software here are subject to change without prior written notice.**
- **All trademarks and registered trademarks are the properties of their respective owners.**
- **If there is any uncertainty or controversy, please refer to the final explanation of us.**
- **Please visit our website or contact your local service engineer for more information.**